

Flow Controllers



Model Z2000

Flow Controllers



Model ZIII

Model Selection Table	P.82
Model Z2000 Flow Controller	P.83

Model ZIII Electronic Needle Valve	P.87
· Safety Instructions	P.92

Liquid Flow Controllers

Model Selection Table

Type	Measurement method	Tube size	Selection Code No.	Flow range
Z2000	Ultrasonic	1/4"	01S	5~100mL/min
			02S	15~300mL/min
			03S	50~1000mL/min
		3/8"	04S	100~2000mL/min
			05S	200~4000mL/min
ZⅢ		1/4"	01A	300mL/min (MAX)
			03A	2L/min (MAX)
		3/8"	04A	6L/min (MAX)
		1/2"	05A	15L/min (MAX)

※The above flow rate range is for DI water.

● Specification check chart

Item	Contents						
Tube size	1/4	•	3/8	•	1/2	•	3/4
Chemical	Name:	Specific gravity:		Temperature:			
	Name:	Specific gravity:		Temperature:			
	Name:	Specific gravity:		Temperature:			
	Name:	Specific gravity:		Temperature:			
Flow control range							
Inlet pressure range							
Pulsation range							
Back pressure							

Model Z2000 Ultrasonic Flow Controller

RoHS2

 CE marking Approval

Z2000

Features

- Ultrasonic flow controller with low pressure loss.
- Corrosive-resistant PTFE is adopted on wetted parts and these valves have outstanding chemical resistance and durability.
- This particular model that valve function and electronic needle valve are integrated, it can be installed at narrow space.
- The power status, flow control status, and alarm status can be checked with the LED indicator.
- Communication port is equipped on the side of the main unit. The dedicated operation software allows you to check the operating status and alarm status, and set various functions.

Specifications

Model	Z2000-1/4-01S	Z2000-1/4-02S	Z2000-1/4-03S	Z2000-3/8-04S	Z2000-3/8-05S
Flow control range	5~100mL/min	15~300mL/min	50~1000mL/min	100~2000mL/min	200~4000mL/min
Fluids	DI water, Chemicals without bubbles · Fluids not corrosive against wetted parts.				
Tube size	1/4"			3/8"	
	Ø6.35×Ø3.95			Ø9.53×Ø6.35	
Connection type	Pillar fitting				
Wetted parts	PTFE, PFA, Kalrez® O-ring				
Pressure range	0~500kPa Differential pressure(ΔP: MAX 300kPa)				
Withstanding pressure	600kPa				
Fluid temperature	15~35°C				
Ambient temperature / Humidity	15~35°C (30~80%RH, Without condensation)				
Flow control accuracy (Accuracy for DI water)	±1%F.S. (5~50ml/min)		±1%F.S.		
	±2%F.S. (50~100ml/min)				
	※Pulsation of supply pressure ±: Within ±15kPa (ΔP: at 50kPa or more)				
Factory calibration state	Fluid: DI water, Fluid temperature: 25°C, Calibration posture: Horizontal				
Responsiveness	Approximately 1.5 seconds (response time up to 95% of set flow) ※Under the condition that the minimum required differential pressure is secured				
Flow measurement method	Ultrasonic				
Valve control method	Electronic control type (needle valve)				
Power supply	DC24V±10%				
Current consumption	Max. 500mA				
Inrush current	5.0A(0.8mS)				
Mounting positions	• Horizontal				
	• Vertical ※ IN: Downward, OUT: Upward · Install at angle of 10° from the wall (raise the "IN" side 10°) • Side ※ Make the back of the base inclined 10° to the wall side (raise the top surface 10°)				
Conforming standard	RoHS2 compliant · Conforms to the CE marking				
Degree of protection	Accordance with IP65				

※When selecting types, please inform the type of fluid (chemical name, viscosity, density), fluid temperature, fluid pressure, and back pressure.

※Fluids that easily generate static electricity can not be used.

※This product valve is not design to be completely closed.

Liquid Flow Controllers

Dimensions

● Z2000-1/4-□S

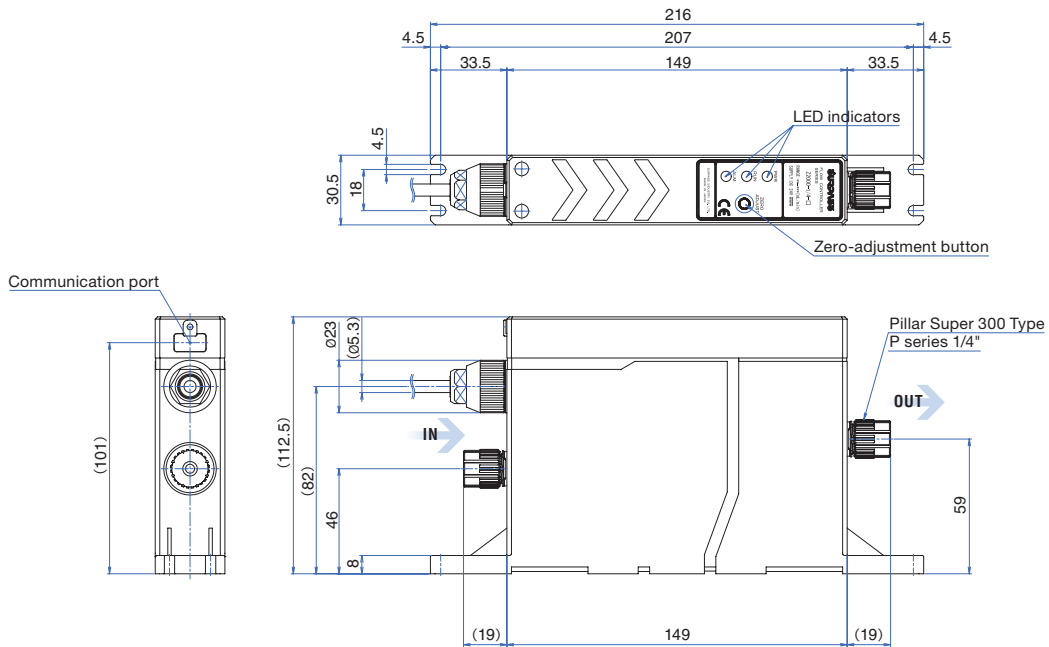

● Z2000-3/8-□S

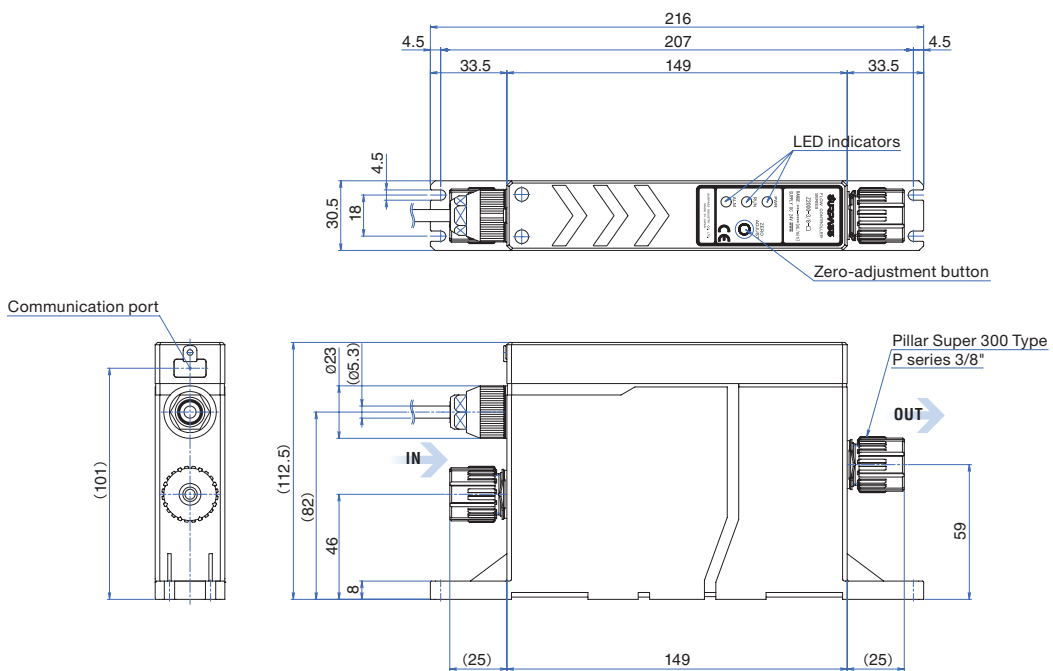

Wiring

Cable No.	Color	IN/OUT	Signals	Description	Specifications	Remarks
1	Red	IN	+24V	+24V power	DC24V±10% (Current consumption MAX 500mA)	
2	Black		GND	0V power		
3	White	OUT	FLOW OUT	Current flow rate	Current output 4~20mA (Load resistance 250Ω or less)	
4	Brown	IN	VALVE FULL OPEN	Valve fully open	Load current when circuit is shorted: 10mA or less Terminal voltage when circuit is open: 24V	Valve fully open → Shorted Normal → Open
5	Blue	IN	TARGET IN	Target flow rate	Current input 4~20mA (Input impedance 250Ω)	
6	Yellow	IN	ZERO START	Start flow rate Zero adjustment	Load current when circuit is shorted: 10mA or less Terminal voltage when circuit is open: 24V	Start zero adjustment → Shorted Normal → Open
7	Gray	OUT	VALVE OPENING	Valve opening	Current output 4 ~ 20mA (Load resistance 250Ω or less)	
8	Green	OUT	ALARM	Alarm	NPN open collector (Load rating DC24V / 30mA or less)	Warning (Alarm) → Open Normal → Shorted

*Ground the shield wire to the frame ground (F.G.).

● Cable specifications

Cable No.	Signals	Cable Color	Item	Specifications
1	+24V	Red	Size	AWG26
2	GND	Black	Number of cores	8 cores
3	FLOW OUT	White	Cable core diameter	Ø1.0
4	VALVE FULL OPEN	Brown	Shielding	OD Ø3.6 shielded wire
5	TARGET IN	Blue	OD	Ø5.3
6	ZERO START	Yellow	Insulation material	PVC covering
7	VALVE OPENING	Gray	Standards	UL style20276
8	ALARM	Green		

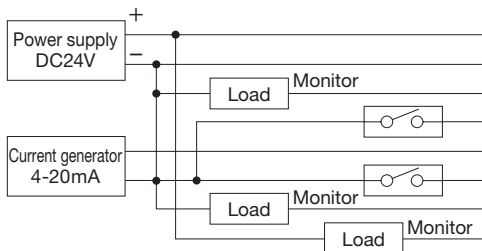

Caution Perform zero adjustment by setting the working fluid temperature and no pressure fluctuation.

Input / output Specification

① Target flow rate(input): [TARGET IN]

$$\text{Current [mA]} = \frac{\text{Target flow rate [mL/min]}}{\text{Max. flow rate of flow control range [mL/min]}} \times 16 + 4$$

*When input target flow rate is at least 80 % of minimum flow control range, flow control starts.

② Current flow rate (output): [FLOW OUT]

$$\text{Current [mA]} = \frac{\text{Current flow rate [mL/min]}}{\text{Max. flow rate of flow control range [mL/min]}} \times 16 + 4$$

*When current flow rate reached less than 80% of minimum flow control range, flow control stops.

● Input / output scaling

Current (mA)	4	20
Target flow rate (L/min)	0	Maximum flow rate in the flow control range
Current flow rate (L/min)		
Valve opening (%)	0	100

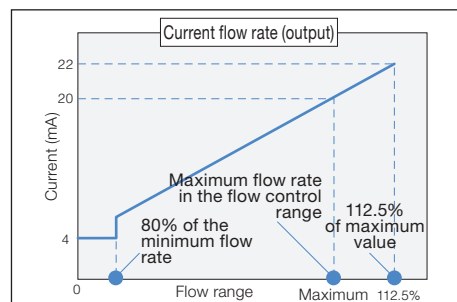
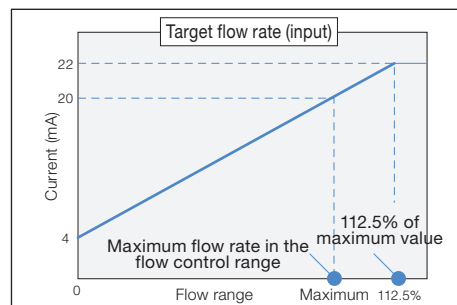

Liquid Flow Controllers

Operation Product

Type **ZLX2-C3M** A cable that required to use the operation software. (sold separately)

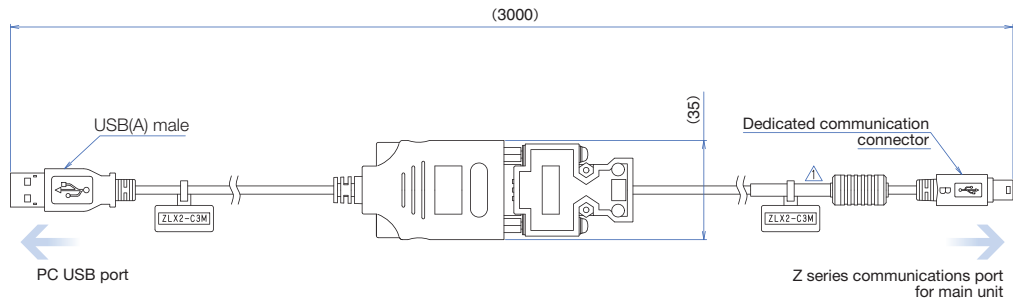

Z2000 operation software

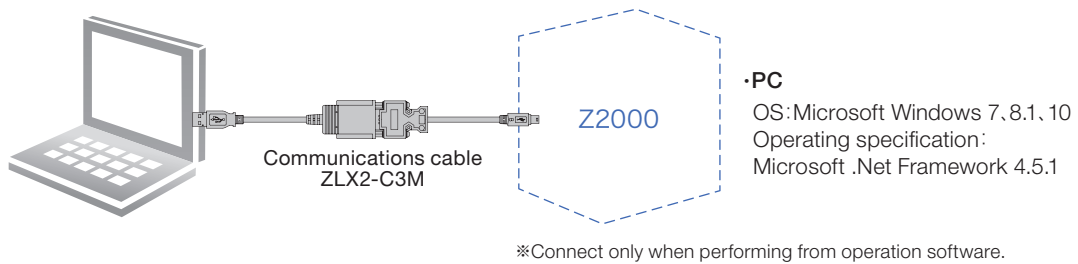

Model ZIII Electronic Needle Valve

RoHS2



Features

- ⦿ Corrosive-resistant PTFE is adopted on wetted parts and those valves have outstanding chemical resistance and durability.
- ⦿ An external signal can be used to set the valve opening.
- ⦿ Equipped with LED indicators to check the power status and other conditions.
- ⦿ Detachable cable is made easy for maintenance.

Specifications

Type	ZIII-1/4-01A	ZIII-1/4-03A	ZIII-3/8-04A	ZIII-1/2-05A
Fluids	DI water, Chemicals ·Not corrosive against wetted parts. ·Not adhere to the wetted part and solidify.			
Tube size	1/4"	1/4"	3/8"	1/2"
	Ø6.35×Ø3.95	Ø6.35×Ø3.95	Ø9.53×Ø6.35	Ø12.7×Ø9.5
Flow range	300mL/min(MAX)	2L/min(MAX)	6L/min(MAX)	15L/min(MAX)
	※ΔP : at 200 kPa or more			
Pressure range	0~500kPa			
Withstanding pressure	600kPa			
Fluid temperature	20~60℃			
Ambient temperature / Humidity	15~40℃ (30~80%RH, Without condensation)			
Wetted parts	PTFE, PFA			PTFE
Connection type	Pillar fitting			
Responsiveness	Approximately 3 seconds (opening time 0~100% response time)			
Power supply	DC24V±10%			
current consumption	Max. 500mA			
Conforming standard	RoHS2 compliant · Conforms to the CE marking			
Degree of protection	Accordance with IP65			
Mounting positions	Horizontal·Vertical (IN : Downward, OUT : Upward) ·Side			
Inrush current	5.0A (0.8mS)			

※When selecting types, please inform the type of fluid (chemical name, viscosity, density), fluid temperature, fluid pressure, and back pressure.

※Fluids that easily generate static electricity can not be used.

※This product valve is not design to be completely closed.

Electronic Needle Valves

Dimensions

● ZIII-□-□

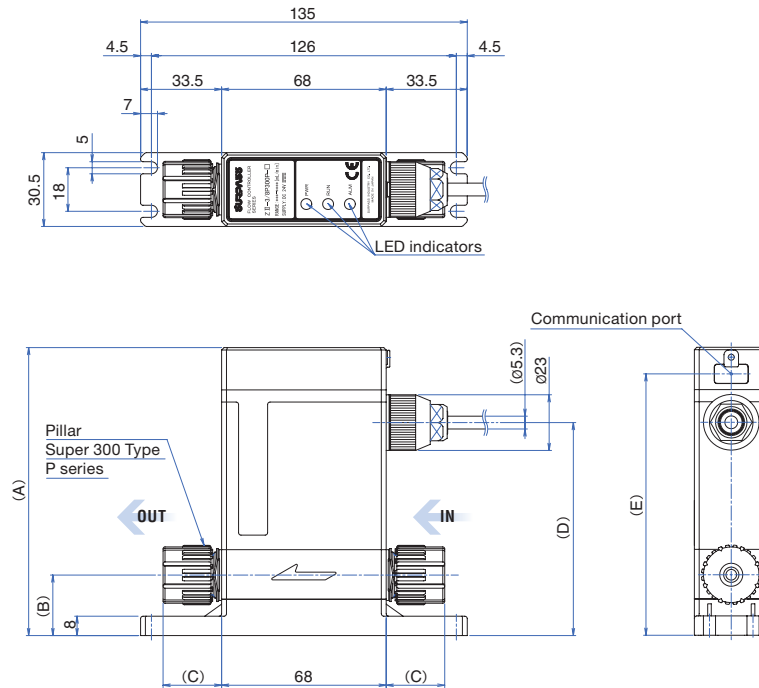

Type	(A)	(B)	(C)	(D)	(E)
ZIII-1/4-01A	114	22	19	83	103
ZIII-1/4-03A	114	22	19	83	103
ZIII-3/8-04A	119	25	25	88	108
ZIII-1/2-05A	124	28	29	93	113

Wiring

Cable No.	Color	IN/OUT	Signals	Description	Specifications	Remarks
1	Red	IN	+24V	+24V power	DV24V±10% (Current consumption MAX 500mA)	
2	Black		GND	0V power		
3	White	OUT	VALVE OPENING	Current opening rate	Current output 4~20mA (Load resistance 250Ω or less)	
4	Brown	/	N.C.	Unused	Current input 4~20mA (Input impedance 250Ω)	
5	Blue	IN	TARGET IN	Setting opening rate	Current input 4~20mA (Input impedance 250Ω)	
6	Yellow	IN	VALVE Adjustment	Valve home position	Load current when circuit is shorted: 10mA or less Terminal voltage when circuit is open: 24V	Valve fully open → Shorted Normal → Open
7	Gray	/	N.C.	Unused	/	/
8	Green	OUT	ALARM	Alarm	NPN open collector (Load rating DC24V/30mA or less)	Warning(Alarm) → Open Normal → Shorted

*Ground the shield wire to the frame ground (FG).
*Do not wire anything to N.C. with insulation treatment.

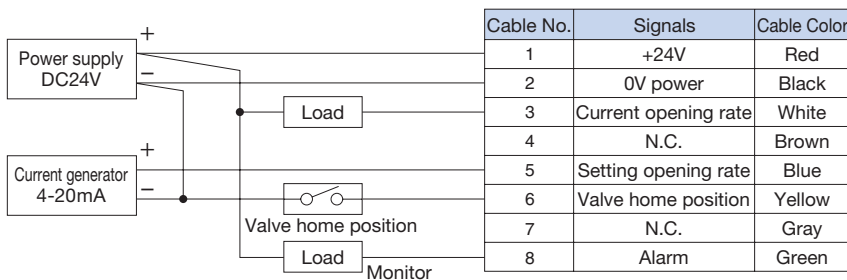

● Cable specifications

Item	Specifications
Size	AWG26
Number of cores	8 cores
Cable core diameter	ø1.0
Shielding	OD Ø3.6 shielded wire
OD	ø5.3
Insulation material	PVC covering
Standards	UL style20276

Input / output Specification

① Target flow rate(input): [TARGET IN]

$$\text{Current [mA]} = \frac{\text{Target valve opening [\%]}}{\text{Fully open valve position 100 [\%]}} \times 16 + 4$$

② Current valve opening (output): [VALVE OPENING]

$$\text{Current [mA]} = \frac{\text{Current valve opening [\%]}}{100 [\%]} \times 16 + 4$$

● Input / output scaling

Current (mA)	4	20
Target valve opening (%)	0	100
Current valve opening (%)	0	100

*The minimum valve seat leakage flow is ensured even at a 0% valve opening, it can not be shutoff completely.

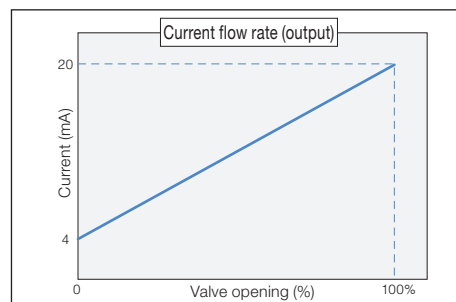
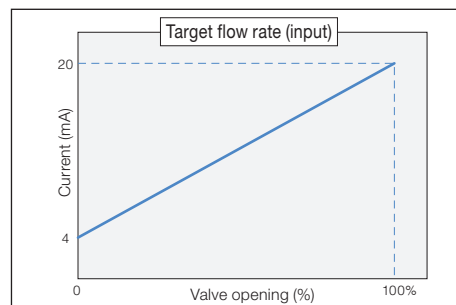

Electronic Needle Valves

Flow Characteristics

● ZIII-1/4-01A

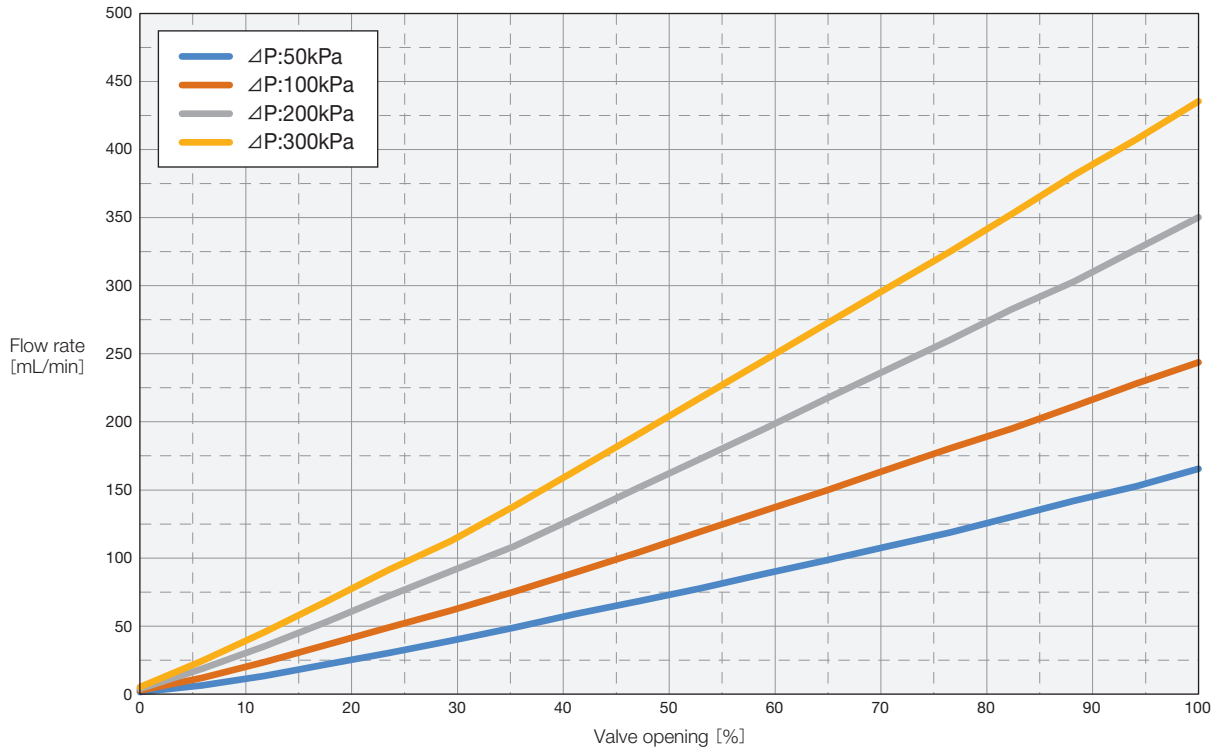

● ZIII-1/4-03A

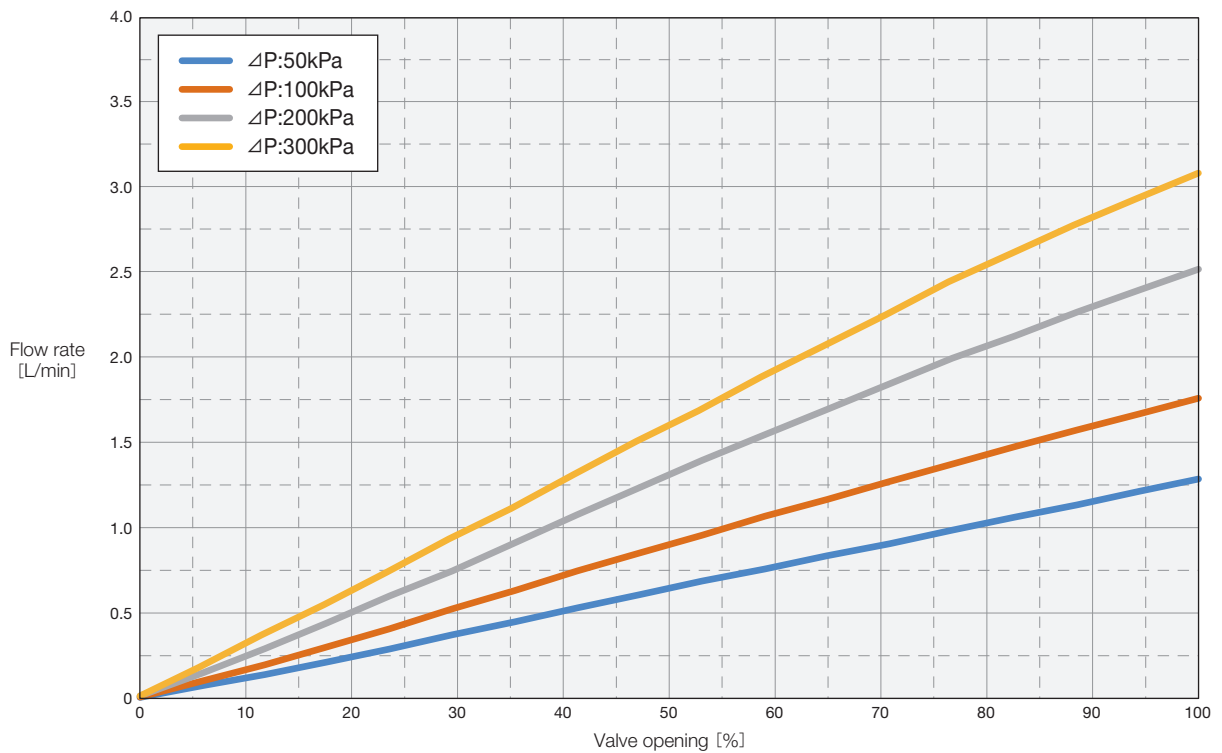

Fluid: DI water Fluid temperature: 25°C Ambient temperature: Room temp.

*The data is reference value, not a guaranteed value.

Flow Characteristics

● ZIII-3/8-04A

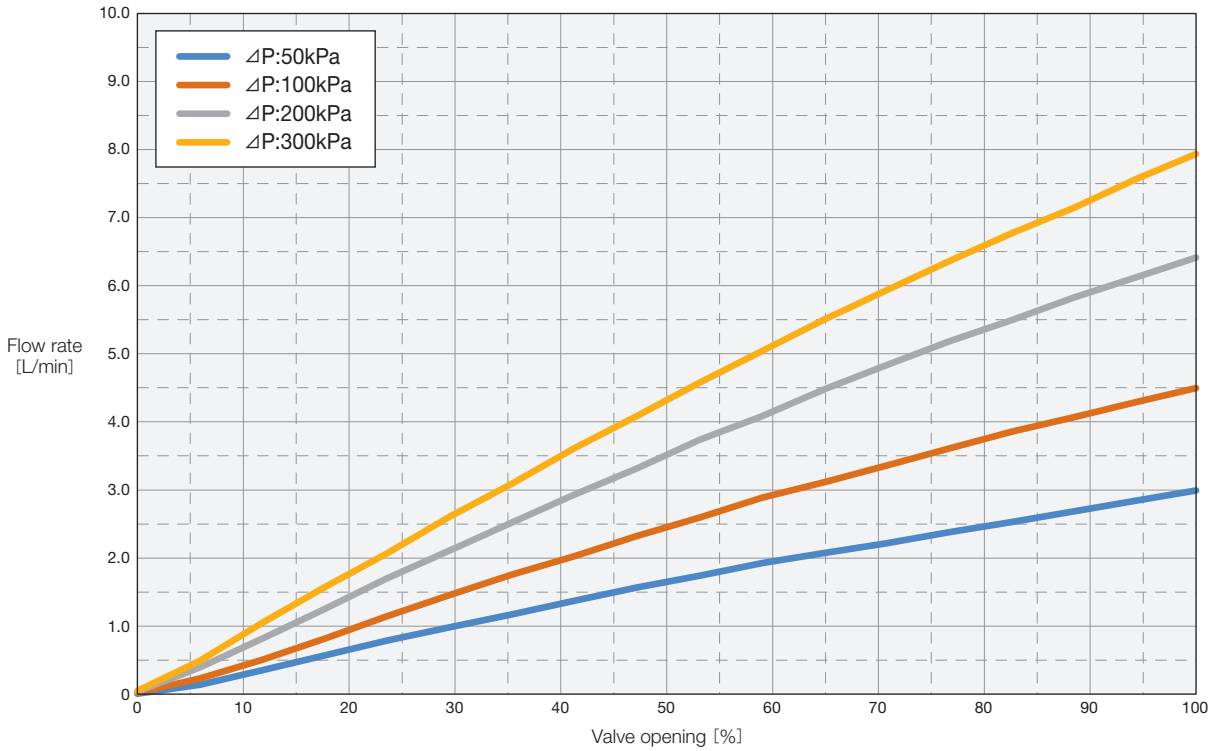

● ZIII-1/2-05A

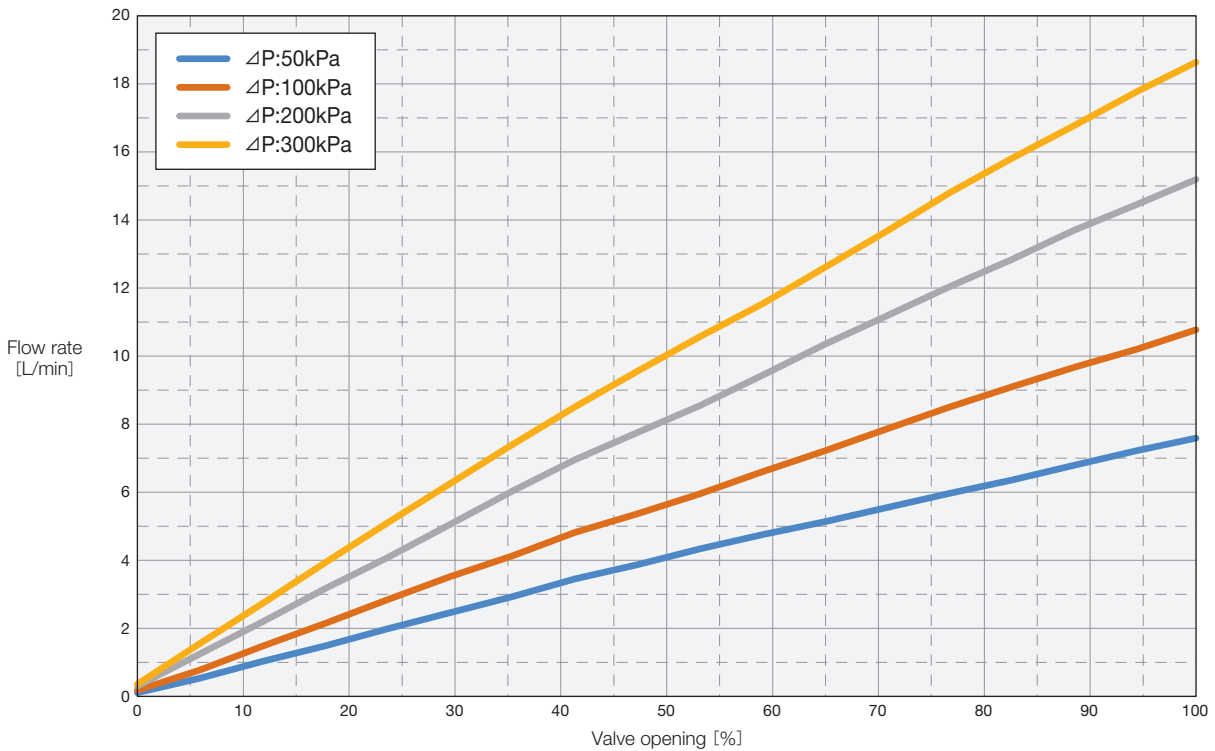

Fluid: DI water Fluid temperature: 25°C Ambient temperature: Room temp.

※The data is reference value, not a guaranteed value.

Electronic Needle Valves

Operation Product

Type **ZLX2-C3M** A cable that required to use the operation software. (sold separately)

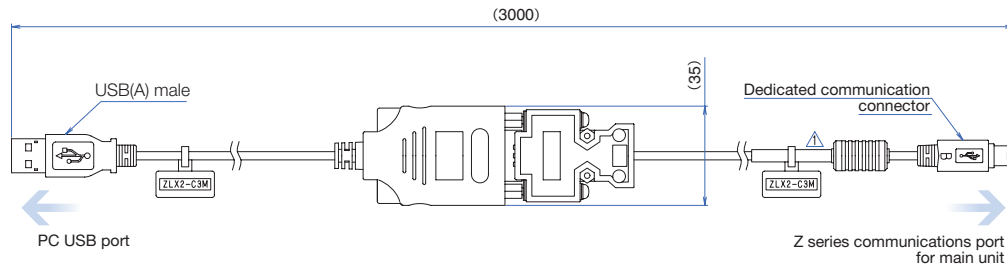

ZⅢ operation software

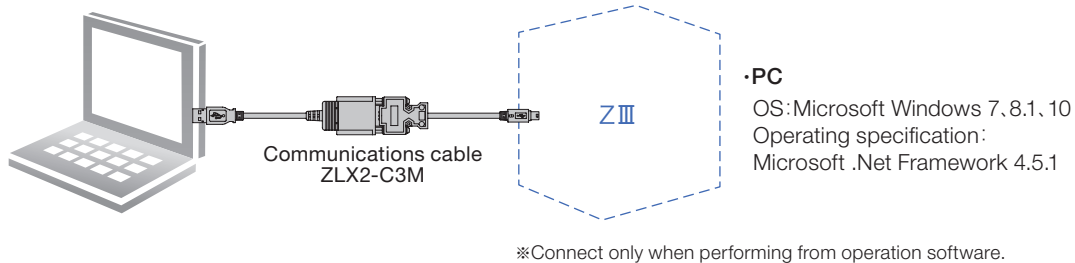

● Safety Instructions



- Before using the product, read the instruction manual carefully and use it correctly. We are not liable for accidents that occurred during use other than those described in the instruction manual.
- Use this product within the specified range.
- Confirm the compatibility of the product material with the type of fluid and ambient atmosphere before use.
- Do not use fluids that contain refuse or foreign matter, as this may interfere with normal function of product.
- Abrasive or coagulate fluids may interfere with normal function, and take measures to prevent stacking residue on the wetted parts.
- Do not disassemble the product.
- Be sure to ground the shield wire to the frame ground (F.G.).
- For zero flow adjustment, be sure to wait at least 5 minutes after the "IN" and "OUT" valves are closed before performing zero adjustment. Fluid temperature should be 25°C.
- If static electricity is generated, the equipment may seriously damage. Please use after applying antistatic measures.
- Do not use the product in a harsh environment where fluid temperature changes rapidly, as this may cause damage to the product.
- Periodic inspection should be performed for safety when using chemical solution with high permeability for long time. It may penetrate the parts, and if there is any functional problem, please take measures such as replacing the product.
- Use the product in the condition that well adapted to the fluid temperature which uses in the device.
- Device can not measure flow rate in case of using the heavily forming liquid. Please take measures such as removing air bubbles.
- Install a pressure reducing valve in the case of sudden pressure condition such as water hammer, excessive pulsating condition, or condition exceeding the pressure range.

● Cautions for piping and installations



- Check the connection with the tube regularly and refer to the instruction manual of each connector manufacturer and follow the recommended installation method.
- When tubing, allow the fluid to flow in the direction mark (→) imprinted on the main unit.
- Connect this product not to apply any bending, tensile or compression, and other forces on it, and do not use the product with excessive vibration or shock.

•Kalrez® is a registered trademark of DuPont.

•Pillar Super 300 Type P series is a trademark of Nippon Pillar Co., Ltd.

LFC-2009-E2.6.0