



**Fluorine Resin Type Pressure Sensor**

**HPIX—SC**

**HPSX—SC**

Operation Manual

Surpass Industry Co., Ltd.

## Read Before Use

- Before using this product, check the compatibility of the type of liquid to use and the wetted parts material in this product.
- All users are required to carefully read and understand this manual before operation of the product.
- Keep this manual in good condition and close at hand for quick reference whenever necessary.
- Use the product only as intended, and only as directed in this manual.
- Cautionary notes in this manual must be fully understood and complied with at all times.



## About This Operation Manual

- The contents of this manual are subject to change without prior notice, due to improvements in product functionalities and / or performance.
- No part of this manual may be reproduced in any form or by any means.
- Although this manual has been prepared with all possible care, please do not hesitate to contact Surpass Industry about errors, omissions, or any other points of doubt.



## Important Safety Instructions

### <Symbols in This Operation Manual>

**Warnings and cautionary** notes are provided in this manual to ensure this product is used correctly and to prevent personal injury and property damage. The meanings of the WARNING and CAUTION symbols in this manual are as described below. Read and understand these notes before reading the rest of this manual.

 <b>DANGER</b>	This symbol indicates warnings against impending danger which, if not observed, may cause death or severe injury to the user.
 <b>WARNING</b>	This symbol indicates warnings which, if not observed, may cause death or severe injury to the user.
 <b>CAUTION</b>	This symbol indicates warnings which, if not observed, may physically impair the user or damage surrounding objects.

## Specific Warnings

 <b>WARNING</b>	 <b>WARNING</b>
<ul style="list-style-type: none"> <li>● This product is not explosion-proof. Never use it with flammable fluids such as solvents. Doing so may cause fire and or explosion and is highly dangerous.</li> <li>● Never disassemble or alter the product. Doing so will cause breakage of the product and possible liquid leakage. The use of dangerous chemicals, solvents, and gases may cause physical impairment.</li> <li>● Do not apply more pressure than the allowed maximum output. Doing so will cause product failure and possible liquid leakage. The use of dangerous chemicals, solvents, and gases may cause physical impairment.</li> <li>● Do not insert screwdrivers, wires, or other objects into the connector parts. Doing so will cause product failure and possible liquid leakage. The use of dangerous chemicals, solvents, and gases may cause physical impairment.</li> <li>● Refrain from excessive pulling or bending of the cables. Doing so may cause wiring disconnections, which may cause electrical shock and fire hazards.</li> <li>● Install the pressure sensor in an area that is dry and clean. Supply power to the pressure sensor from an isolation transformer (switching power supply) rated for 24 VDC or less. Make sure the rated power output is 150 VA and does not exceed 2A. (Use exclusively for class 2 circuits)</li> </ul>	<ul style="list-style-type: none"> <li>● When mounting connector parts, comply with the instructions issued by each connector manufacturer. Loose connections may result in disconnection or chemical leakage. The use of dangerous chemicals, solvents, and gases may cause physical impairment.</li> <li>● Do not use the product in areas where corrosive gases are being ejected. Corrosion in the pressure sensor and connector may result in liquid leakage. The use of dangerous chemicals, solvents, and gases may cause physical impairment.</li> <li>● Obey these instructions. <ul style="list-style-type: none"> <li>- Refrain from excessive tightening of the connector parts.</li> <li>- Do not install the product in areas of excessive vibration or shock.</li> <li>- Use the product only within the specified operating environment. Otherwise, damage to the pressure sensor and connector may occur and result in liquid leakage. The use of dangerous chemicals, solvents, and gases may cause physical impairment.</li> </ul> </li> <li>● Protect all wiring used by providing support along the wiring at appropriate distances.</li> <li>● For shielded cables, peel the sheath at the very end of the cable and connect the shield to the chassis or mounting plate, etc., using the proper tool (recommended tool: Nitto Supply AL-2).</li> </ul>

## Product Description

### <Applications>

PTFE Pressure Sensors can be used as semiconductor manufacturing devices or as pressure monitor/process control devices for chemical processes, high-purity fluids, etc.

### <Features>

- All models comply with the RoHS directive.
- The wetted part is fully made of fluorine resin allowing it be used with a variety of chemicals.
- Because the Pressure Sensors use strain gauges, they offer you excellent reliability and durability.
- The Zero Adjust button allows easy adjustment in the field.
- Zero adjust is also possible by remote control using the External Zero Adjust function.
- A green LED indicator is provided on top of the case for easy recognition of power-on status (lit), and zero adjust (flashing).

## Specifications

Model	HPIX	HPSX
Type	Inline type	Straight type
Standard Rated Pressure Range	0 to 500kPa (see nameplate)	
Withstanding Pressure	150% of Rated Pressure Range (for 0 to 700kPa, the withstand pressure is 800kPa)	
Pressure Type	Gauge Pressure	
Applicable Fluid	Liquids, gases	
Linearity	±1%F.S.	
Hysteresis	±1%F.S.	
Temperature Effects	±0.05%F.S./°C	
Output	Current	DC 4 to 20 mA
	Voltage	DC 1 to 5 V
Power supply/zero tracking output	Max. 30V, 8 mA (NPN open collector)	
Power Supply	DC 12 to 24 V±10%	
Current Consumption	Max.50 mA (12V), Max.42 mA (24V)	
Environmental Temperature Range	15 to 50°C	
Fluid Temperature Range	15 to 80°C	
Standard Cable	6-core shielded cable (AWG 28), OD 4.8 mm 2 m (PTFE sheath)	
Wetted Parts Material	PTFE, PFA (differs by model)	
Main Color	Red	
Protection Class	Accordance with IP65	

**Outer Dimensions**

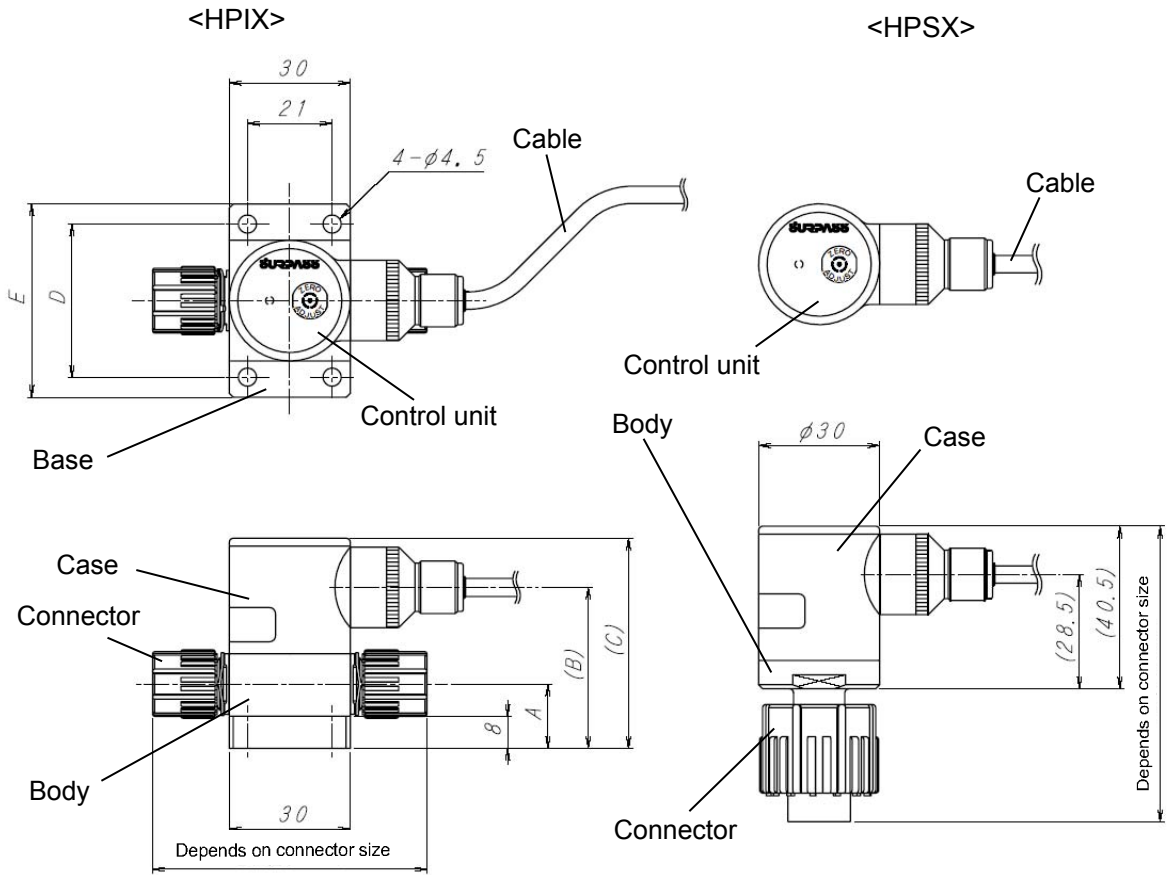

Model	A	(B)	(C)	D	E
HPIX-12	16	(40)	(52)	38	48
HPIX-13	20	(47)	(59)	38	48
HPIX-14	20	(48.5)	(60.5)	38	48
HPIX-16	24	(63.5)	(75.5)	42	50

**Names and Functions on the Control Unit**

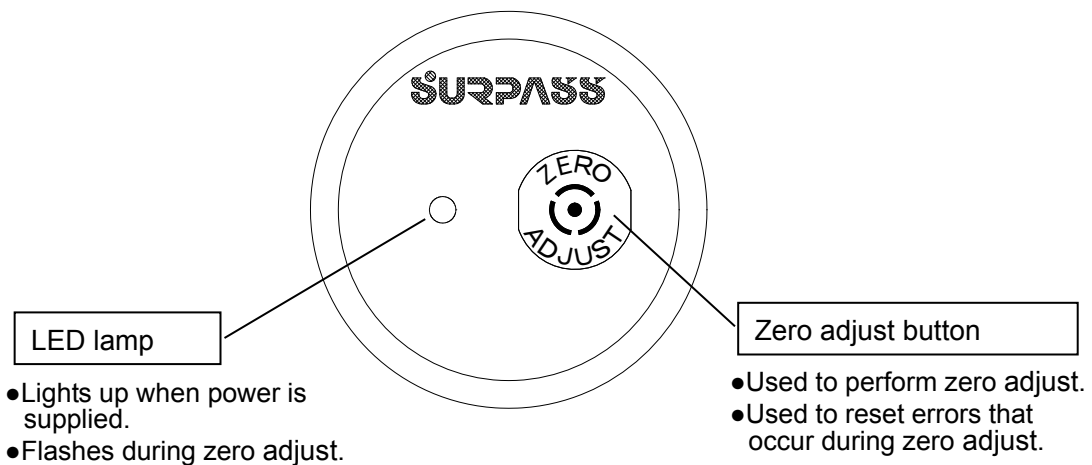

## Mounting and Connecting the Connector Parts

<Inline type>

If you wish to anchor your Pressure Sensor, always use the mounting holes in the base.

In order to install connector parts correctly, always refer to the relevant catalog or operation manual issued by the connector manufacturer.

<Straight type>

When connecting the connector parts, clamp the sides of the body (WAF: 27 mm) with the dedicated tool for the connector, and tighten the connector while preventing the body from turning.

In order to install connector parts correctly, always refer to the relevant catalog or operation manual issued by the connector manufacturer.

### ⚠ WARNING

- When mounting connector parts, comply with the instructions issued by each connector manufacturer. Loose connections may result in disconnection or chemical leakage. The use of dangerous chemicals, solvents, and gases may cause physical impairment.
- Refrain from excessive tightening of the connector parts. Otherwise, damage to the pressure sensor and connector may occur and result in liquid leakage. The use of dangerous chemicals, solvents, and gases may cause physical impairment.

### ⚠ CAUTION

- When tightening the connector, do not tighten it while holding or rotating the case. The case may damage the product when it is rotating.
- The case and the operation panel of the product is not revolving. The case may damage the product when it is rotating.
- Please do not rotate the pressure sensor after tightening the connector. If change the direction, Please loosen the connector.

## Points to Observe When Installing

To prevent erroneous operation or premature wear, do not install in:

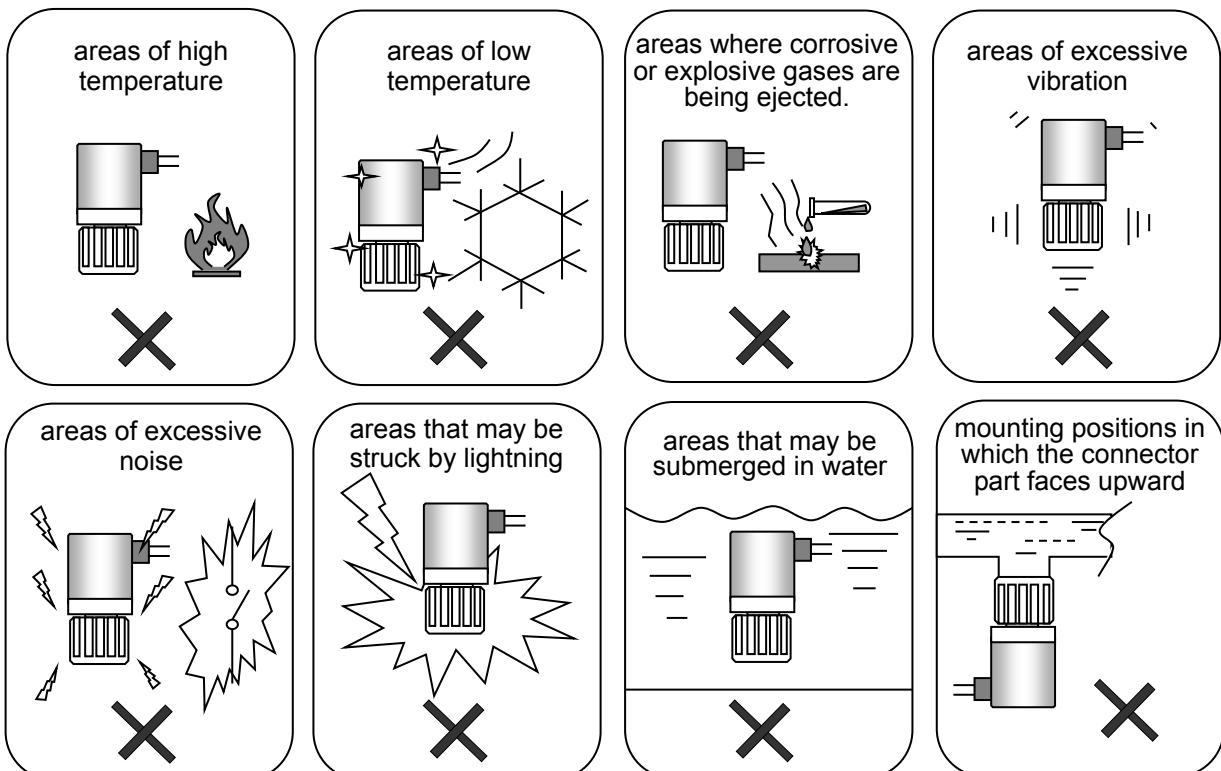

## Wiring

Observe these precautions to connect the leads correctly.

### ⚠ CAUTION

- Never do wiring work when power supply is on. Doing so may cause electrical shock.
- Do not pull or bend the cable forcibly. It may cause breakage of the cable, electrical shock, or fire. In addition, pulling the cable forcibly rotates the case, which may result in the damage to the product.
- Make sure to connect all leads correctly. Failure to do so may cause the product to fail.  
Do not connect a power supply to Blue line and Black line, because they are connected inside.  
If they are connected to a power supply, a product breaks down..
- If you are using a commercially available switching regulator as a power supply, always ground it to an F.G. terminal. If electricity leaks to earth, it may cause electrical shock.
- Connect the shield on shielded cables to the frame ground as necessary.

<Pressure sensor wiring diagram>

#### Current output

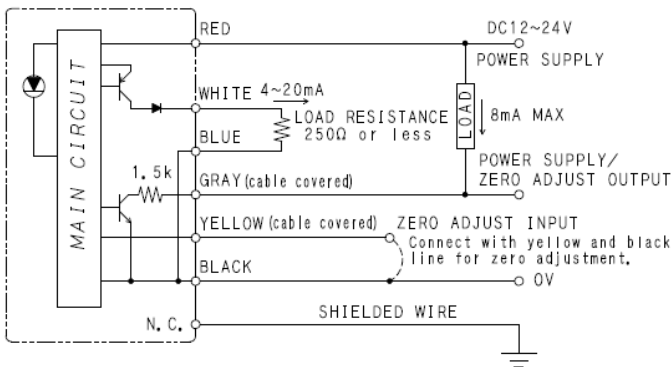

#### Voltage output

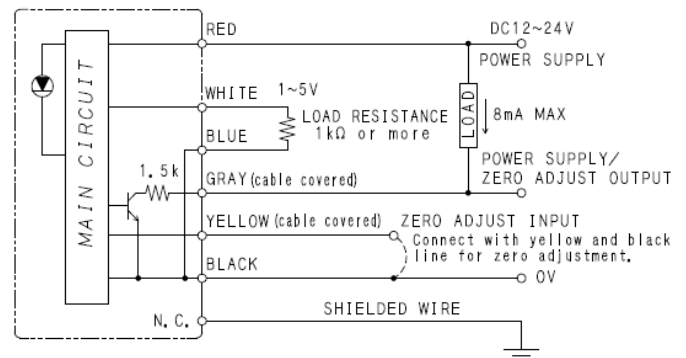

## How to Use

Check the following items before using your Pressure Sensor.

- (1) Make the Pressure Sensor open to the atmosphere (0kPa) and apply the power.
- (2) Warm up your equipment by running "on empty" for approximately 20 minutes after power-on.
- (3) Check to see that the externally displayed pressure and analog output values are as shown below.

Externally displayed pressure: 0 kPa  
Analog output values  
Current: 4 mA  
Voltage: 1 V

- (4) If the externally displayed pressure or analog output values are not as shown below, you will need to do zero adjust following the instructions in "How to Do Zero Adjust".

Externally displayed pressure: 0 kPa  
Analog output values  
Current: 4 mA  
Voltage: 1 V

## How to Do Zero Adjust

### ◇ Using the Zero Adjust button

- (1) Make sure that your Pressure Sensor is opened to the atmospheric state.
- (2) Press and hold the Zero Adjust button for at least three seconds.

#### Zero Adjust conditions:

- Open to the atmospheric state.
  - Pressure fluctuation must be within  $\pm 1\%$  F.S.
- The LED will flash.

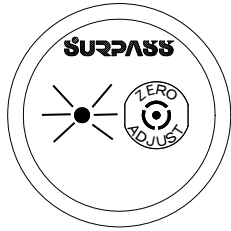

- When you release your hand from the Zero Adjust button, zero adjust will start.

### ⚠ CAUTION

Before doing the zero adjust procedure, Pressure Sensor is opened to the atmospheric state

- (3) After the zero adjust is complete, the LED lamp will change from a flashing state to a constantly lit state. The pressure sensor returns to measurement mode.

#### [Zero adjust error]

If the LED lamp keeps flashing after at least three seconds from the time zero adjust started, it is the indication of a zero adjust error.

- When zero tracking is in progress, an error will occur if the pressure in your piping system fluctuates by  $\pm 1\%$  F.S. or more.
- To reset the error, press and hold the Zero Adjust button for at least one second.

After the error resets, redo the zero adjust procedure from Step (1), as described in ◇Using the Zero Adjust button.

### ◇ Zero adjust by external input

- (1) Make sure that your Pressure Sensor is opened to the atmospheric state.
- (2) Short circuit the Zero Adjust input signal for at least three seconds.

#### Zero adjust conditions:

- Open to the atmospheric state.
  - Pressure fluctuation must be within  $\pm 1\%$  F.S.
- When zero adjust starts, the zero adjust output alternates ON/OFF every 0.2 seconds.
  - Zero adjust begins when the Zero Adjust input is opened.

### ⚠ CAUTION

Before doing the zero adjust procedure, Pressure Sensor is opened to the atmospheric state

- (3) When zero adjustments is complete, the zero adjustment output transistor activate (short the output signal to 0V) and resume measurement mode.

#### [Zero adjust error]

If the zero adjust output keeps alternating ON/OFF after at least three seconds from the time zero adjust started, it is the indication of a zero adjust error.

- When zero adjust is in progress, an error will occur if the pressure in your piping system fluctuates by  $\pm 1\%$  F.S. or more.
- To reset the error, short circuit the zero adjust input for at least one second.

After the error resets, redo the zero adjust procedure from Step (1), as described in ◇Zero Adjust by external input.



Periodically provide the ZERO point adjustment.

## Cable Removal Method

◇ Name of each part

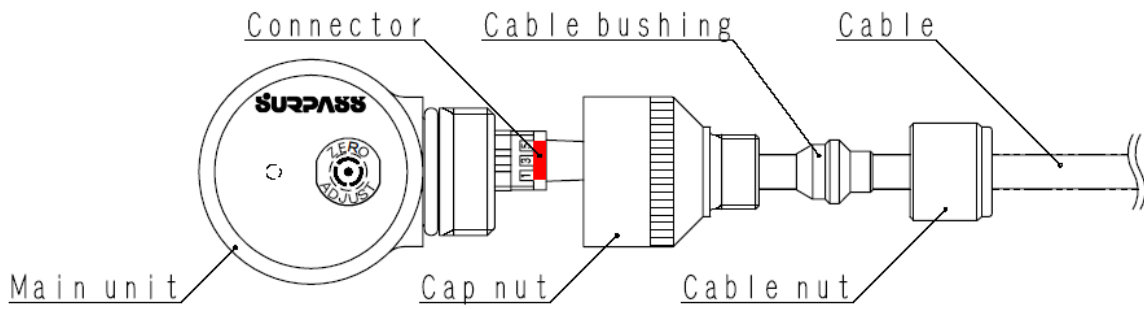

◇ Cable remove method

- ① Check that the power of the main unit is off

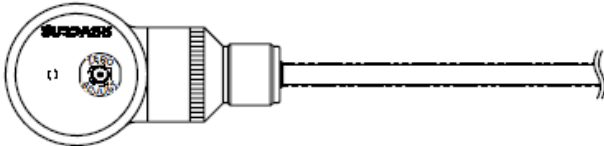

- ② Hold the cap nut and remove the cable nut

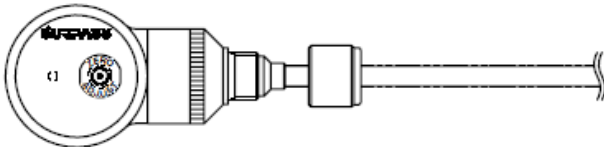

- ③ Hold the cable and remove the cable bushing

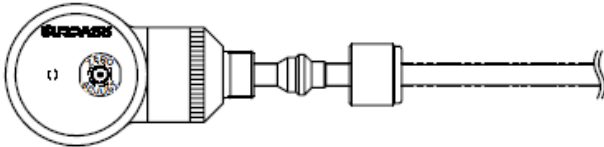

- ④ Hold the main unit and remove the cap nut

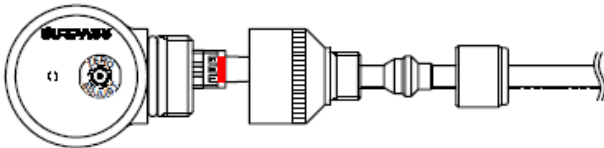

- ⑤ Hold the main unit and disconnect the cable connector (be sure to hold the connector)

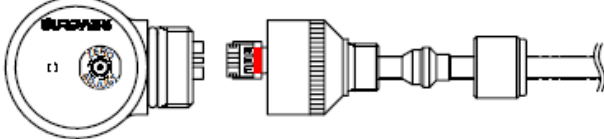

◇ Cable installation method

- ① Check that power is not supplied to the cable

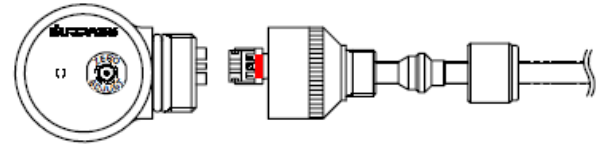

- ② Hold the main unit and connect the cable connector (connect so that the red seal is on the top side of the main unit)

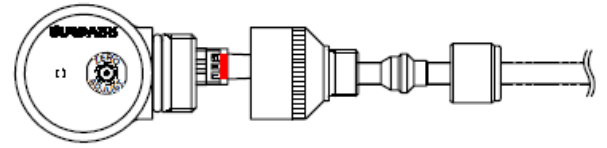

- ③ Hold the main unit and attach the cap nut

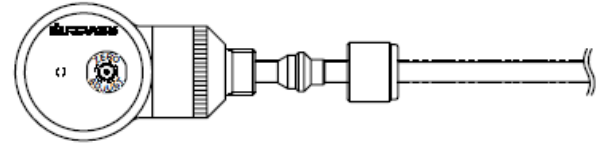

- ④ Hold the cable and attach the cable bushing

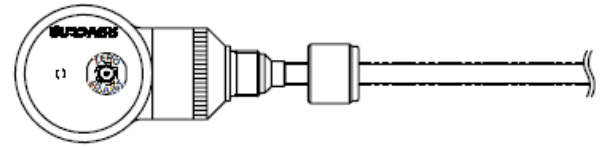

- ⑤ Hold the cap nut and attach the cable nut

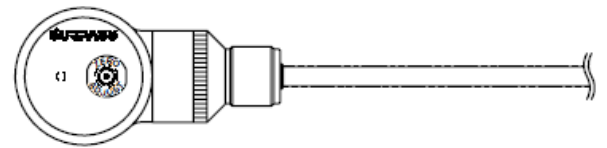



## Maintenance and Inspection

The Pressure Sensor should be inspected regularly, about twice a year depending on the usage.

During the regular inspection, check the

- appearance
- corrosion, clogging, leakage, etc., from the connector parts.

The Pressure Sensor should be flushed periodically if using liquids that crystallize easily.

<Safety Notes on Maintenance and Inspection>

 <b>DANGER</b> unless these precautions are not obeyed!	
<ul style="list-style-type: none"> <li>● If using dangerous chemicals, solvents, gases, etc., make sure to wear protective, chemical resistant gear (protective gloves, mask, and clothing) to protect your entire body. Ejected liquids may result in physical impairment.</li> <li>● Before disconnecting this product from the piping system, make sure the line is depressurized. Otherwise, the fluid inside will eject and may result in physical impairment.</li> <li>● When replacing parts, or when performing maintenance or inspection, turn off the switch, and release the fluid inside the piping to depressurize the line. Otherwise, the fluid inside will eject and may result in physical impairment.</li> </ul>	

## In Case of Breakdown

Symptom	Cause	Countermeasure
Does not power up (LED lamp does not light up.)	Incorrect wiring.	Check the wiring diagram and correct the wiring.
	Incompatible power, voltage.	Check the power supply and voltage.
The externally displayed pressure value does not reach 0 kPa.	The equipment has not been warmed up.	Warm up the equipment for at least 20 minutes.
	Zero point is off.	Adjust the zero point.
Zero adjust fails.	The pressure inside your piping system is fluctuating.	Vent the piping system to atmospheric state.
	Incorrect wiring.	Check the wiring diagram and correct the wiring.
The LED does not change from flashing to lit condition.	During the zero adjust process, the pressure in your piping system fluctuated by $\pm 1\%$ F.S. or more.	Press and hold the zero adjust button for 1 or more second to reset the error. Adjust the pressure in your piping so that it fluctuates less than $\pm 1\%$ F.S. Then repeat zero adjust.
No analog output.	Incorrect wiring.	Check the wiring diagram and correct the wiring.
The analog output value is unstable.	There is noise-generating equipment nearby.	Move the noise-generating equipment from the vicinity.
	The shield wire is not grounded.	Ground the shield wire.
	The pressure inside your piping system is fluctuating.	Stop the pressure inside your piping system from fluctuating.

Notify your nearest sales office for problems not listed above.

**Notes on Warranty**

The warranty runs for one year after the day when Surpass Industry products are delivered from Surpass factory in Japan. In case Surpass Industry should agree in writing that the defects in performance or material were caused by faulty design or workmanship of Surpass Industry, replacement products will be supplied free of charge. This warranty shall not be applied to any defects caused by misuse, alteration, neglectful treatment, and neglect of our recommendations or instructions.

In addition, we are not be liable to any direct or consequential loss, damage, and personal injury due to an unauthorized usage in combination with other products and an improper usage outside of the specifications. Our product warranty shall be limited to replacement of product.

Replacement with expense to the purchaser shall be applied to the followings:

- Any defective products caused by usage that is not described in the Instruction Manual.
- Any defective products caused by neglectful treatment.
- Any defective products caused by decomposition, alteration, and improper adjustment or repair.
- Any defects of products caused by acts of God including natural disaster or fires.
- Consumables and accessories.

The logo for Surpass Industry Co., Ltd. features the word "SURPASS" in a bold, blue, sans-serif font. A small red circle is positioned above the letter "S".

**Surpass Industry Co., Ltd.**

2203 Shimooshi, Gyoda-shi, Saitama 361-0037 Japan

TEL: +81 48 554 9760 FAX: +81 48 554 9906

URL: <http://www.surpassindustry.co.jp>

© 2012-2020 Surpass Industry Co.,Ltd. All rights reserved.