



Fluorine Resin Type Pressure Sensor

HPI

HPS

Operation Manual

Surpass Industry Co., Ltd.

Read Before Use

- Before using this product, check the compatibility of the type of liquid to use and the wetted parts material in this product.
- All users are required to carefully read and understand this manual before operation of the product.
- Keep this manual in good condition and close at hand for quick reference whenever necessary.
- Use the product only as intended, and only as directed in this manual.
- Cautionary notes in this manual must be fully understood and complied with at all times.



About This Operation Manual

- The contents of this manual are subject to change without prior notice, due to improvements in product functionalities and / or performance.
- No part of this manual may be reproduced in any form or by any means.
- Although this manual has been prepared with all possible care, please do not hesitate to contact Surpass Industry about errors, omissions, or any other points of doubt.



Important Safety Instructions

<Symbols in This Operation Manual>

Warnings and cautionary notes are provided in this manual to ensure this product is used correctly and to prevent personal injury and property damage. The meanings of the WARNING and CAUTION symbols in this manual are as described below. Read and understand these notes before reading the rest of this manual.

 DANGER	This symbol indicates warnings against impending danger which, if not observed, may cause death or severe injury to the user.
 WARNING	This symbol indicates warnings which, if not observed, may cause death or severe injury to the user.
 CAUTION	This symbol indicates warnings which, if not observed, may physically impair the user or damage surrounding objects.

Specific Warnings

 WARNING	 WARNING
<ul style="list-style-type: none"> ● This product is not explosion-proof. Never use it with flammable fluids such as solvents. Doing so may cause fire and or explosion and is highly dangerous. ● Never disassemble or alter the product. Doing so will cause breakage of the product and possible liquid leakage. The use of dangerous chemicals, solvents, and gases may cause physical impairment. ● Do not apply more pressure than the allowed maximum output. Doing so will cause product failure and possible liquid leakage. The use of dangerous chemicals, solvents, and gases may cause physical impairment. ● Do not insert screwdrivers, wires, or other objects into the connector parts. Doing so will cause product failure and possible liquid leakage. The use of dangerous chemicals, solvents, and gases may cause physical impairment. ● Refrain from excessive pulling or bending of the cables. Doing so may cause wiring disconnections, which may cause electrical shock and fire hazards. ● Install the pressure sensor in an area that is dry and clean. Supply power to the pressure sensor from an isolation transformer (switching power supply) rated for 24 VDC or less. Make sure the rated power output is 150 VA and does not exceed 2A. (Use exclusively for class 2 circuits) 	<ul style="list-style-type: none"> ● When mounting connector parts, comply with the instructions issued by each connector manufacturer. Loose connections may result in disconnection or chemical leakage. The use of dangerous chemicals, solvents, and gases may cause physical impairment. ● Do not use the product in areas where corrosive gases are being ejected. Corrosion in the pressure sensor and connector may result in liquid leakage. The use of dangerous chemicals, solvents, and gases may cause physical impairment. ● Obey these instructions. <ul style="list-style-type: none"> - Refrain from excessive tightening of the connector parts. - Do not install the product in areas of excessive vibration or shock. - Use the product only within the specified operating environment. Otherwise, damage to the pressure sensor and connector may occur and result in liquid leakage. The use of dangerous chemicals, solvents, and gases may cause physical impairment. ● Protect all wiring used by providing support along the wiring at appropriate distances. ● For shielded cables, peel the sheath at the very end of the cable and connect the shield to the chassis or mounting plate, etc., using the proper tool (recommended tool: Nitto Supply AL-2).

Product Description

<Applications>

PTFE Pressure Sensors can be used as semiconductor manufacturing devices or as pressure monitor/process control devices for chemical processes, high-purity fluids, etc.

<Features>

- Comply with the RoHS directive and CE Marking.
- The wetted part is fully made of fluorine resin allowing it be used with a variety of chemicals.
- Because the Pressure Sensors use strain gauges, they offer you excellent reliability and durability.

Specifications

Model	HPI	HPS
Type	Inline type	Straight type
Pressure Range	0 ~ 300kPa 0 ~ 500kPa 0 ~ 700kPa -100 ~ 300kPa -100 ~ 500kPa	
Withstanding Pressure	150% of Maximum Pressure Range(800kPa or less)	
Pressure Type	Gauge Pressure, Compound Pressure	
Applicable Fluid	Liquids, gases	
Linearity	±1%F.S.	
Hysteresis	±1%F.S.	
Temperature Effects	±0.08%F.S./°C	
Output	Current	DC 4 to 20 mA
	Voltage	DC 1 to 5 V DC 0 to 10 V
Power supply	Current output	DC 24 V±10%
	Voltage output	DC 12 to 24 V±10%
Current Consumption	Current output	Max.30 mA
	Voltage output	Max.20 mA
Environmental Temperature Range	15 to 50°C	
Fluid Temperature Range	15 to 80°C	
Standard Cable	4-core shielded cable (AWG 26), OD 4.5 mm 2 m (PTFE sheath)	
Wetted Parts Material	PTFE, PFA (differs by model)	
Main Color	Red	
Protection Class	Accordance with IP65	

Outer Dimensions

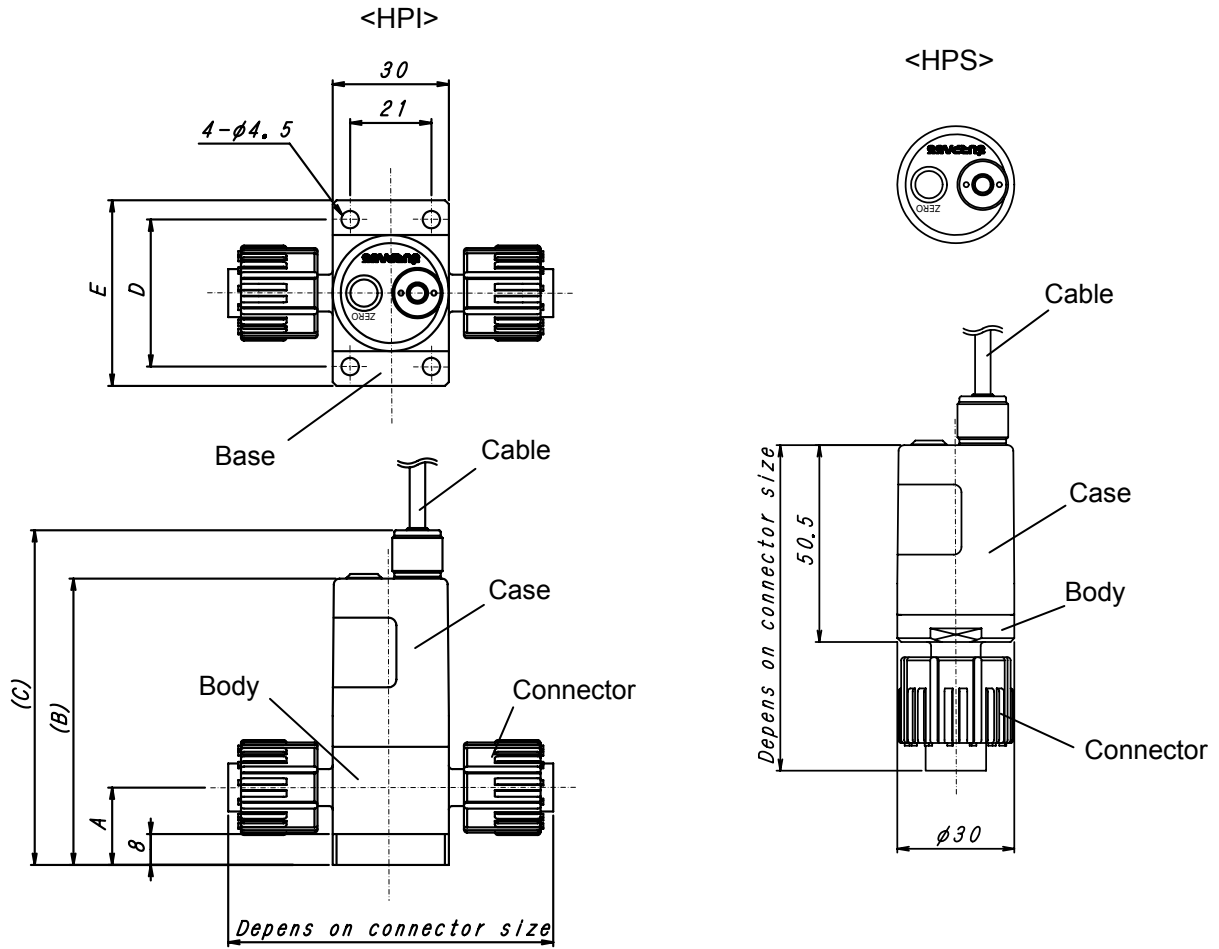

Model	A	(B)	(C)	D	E
HPI-1/4	16	(67)	(80)	38	48
HPI-3/8	20	(74)	(87)	38	48
HPI-1/2	20	(76)	(88)	38	48
HPI-12	16	(67)	(80)	38	48
HPI-13	20	(74)	(87)	38	48
HPI-14	20	(76)	(88)	38	48
HPI-16	24	(85)	(97)	42	50
HPI-D	20	(67)	(80)	38	48
HPI-E	20	(74)	(87)	38	48
HPI-F	20	(74)	(87)	38	48
HPI-G	20	(76)	(88)	38	48

Mounting and Connecting the Connector Parts

<Inline type>

If you wish to anchor your Pressure Sensor, always use the mounting holes in the base.

In order to install connector parts correctly, always refer to the relevant catalog or operation manual issued by the connector manufacturer.

<Straight type>

When connecting the connector parts, clamp the sides of the body (WAF: 27 mm) with the dedicated tool for the connector, and tighten the connector while preventing the body from turning.

In order to install connector parts correctly, always refer to the relevant catalog or operation manual issued by the connector manufacturer.

⚠ WARNING

- When mounting connector parts, comply with the instructions issued by each connector manufacturer. Loose connections may result in disconnection or chemical leakage. The use of dangerous chemicals, solvents, and gases may cause physical impairment.
- Refrain from excessive tightening of the connector parts. Otherwise, damage to the pressure sensor and connector may occur and result in liquid leakage. The use of dangerous chemicals, solvents, and gases may cause physical impairment.

⚠ CAUTION

When tightening the connector, do not tighten it while holding or rotating the case. The case may damage the product when it is rotating.
The case of the product is not revolving. The case may damage the product when it is rotating.

Points to Observe When Installing

To prevent erroneous operation or premature wear, do not install in:

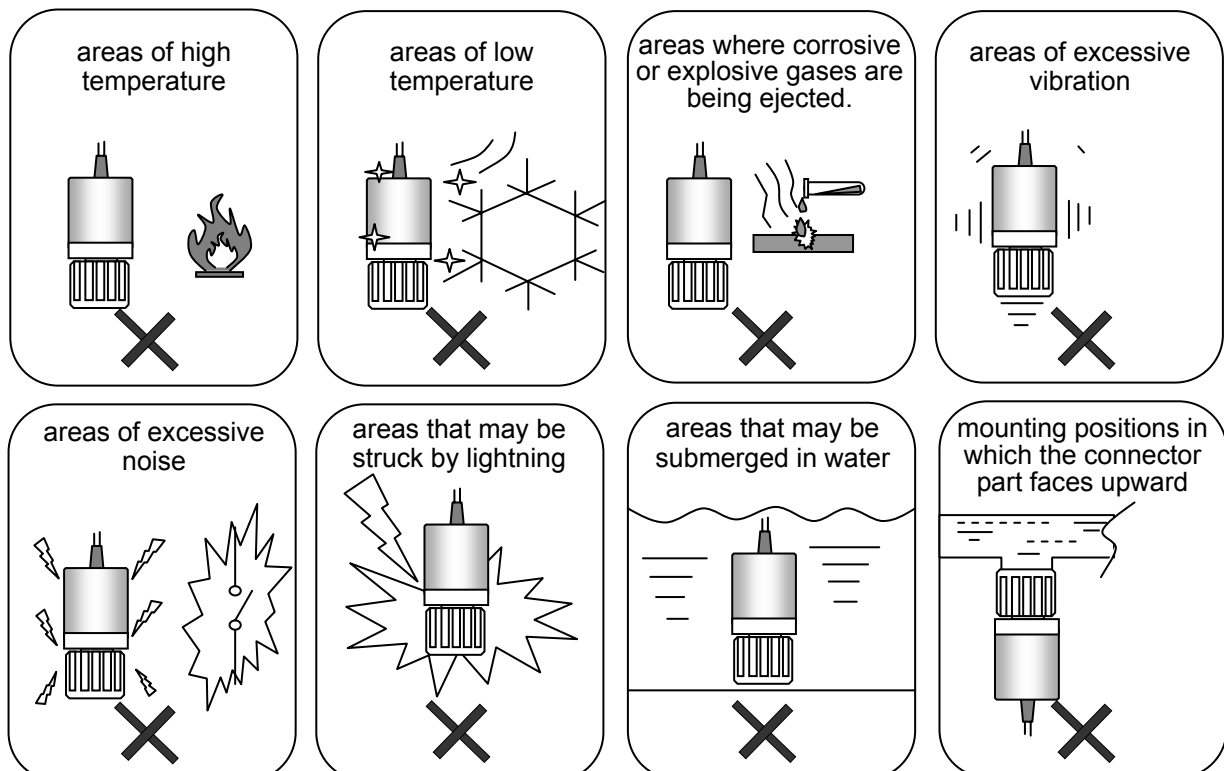

Wiring

Observe these precautions to connect the leads correctly.

⚠ CAUTION

- Never do wiring work when power supply is on. Doing so may cause electrical shock.
- Refrain from excessive pulling or bending of the cables. Doing so may cause disconnections which may cause electrical shock and fire hazards.
- Make sure to connect all leads correctly. Failure to do so may cause the product to fail.
- If you are using a commercially available switching regulator as a power supply, always ground it to an F.G. terminal. If electricity leaks to earth, it may cause electrical shock.
- Connect the shield on shielded cables to the frame ground as necessary.

<Pressure sensor wiring diagram>

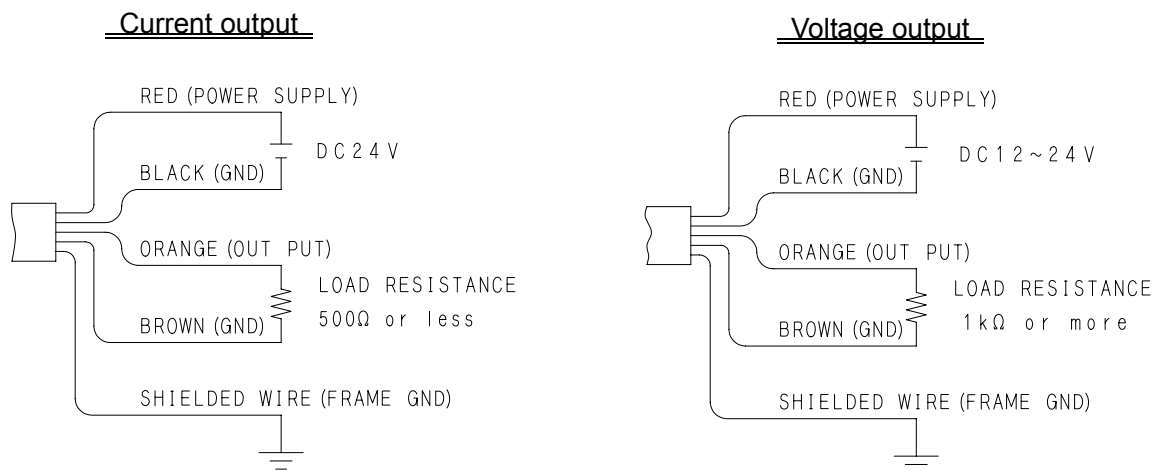

How to Use

Check the following items before using your Pressure Sensor.

- (1) After making sure that your Pressure Sensor is not in a pressurized condition, switch the power supply ON.
- (2) Warm up your equipment by running “on empty” for approximately 20 minutes after power-on.
- (3) Check to see that the externally displayed pressure and output values are as shown below when the pressure sensor is not in a pressurized condition.
- (4) If the externally displayed pressure or output values are not as shown below when the pressure sensor is not in a pressurized condition, you will need to do zero tracking following the instructions in “How to Do Zero Tracking”.

【 Gauge Pressure TYPE 】

Externally displayed pressure : 0 kPa
Output values

Current : 4 mA
Voltage : 1 V (1 to 5 V)
0 V (0 to 10 V)

【 Compound Pressure TYPE 】

Externally displayed pressure : 0 kPa
Output values

Pressure Range	Output set up values	Output Current values (4 to 20 mA)	Output Voltage values (1 to 5 V)	Output Voltage values (0 to 10 V)
-100 ~ 300 kPa		8 mA	2 V	2.5 V
-100 ~ 500 kPa		6.67 mA	1.67 V	1.67 V

How to Do Zero Tracking

【 Gauge Pressure TYPE 】

- (1) Make sure that your Pressure Sensor is not in a pressurized condition.
- (2) Remove the cap (black) from the cable side of the pressure sensor.



- (3) Adjust the externally displayed pressure or output values are as shown below by tuning the ZERO volume control using a slotted screwdriver.

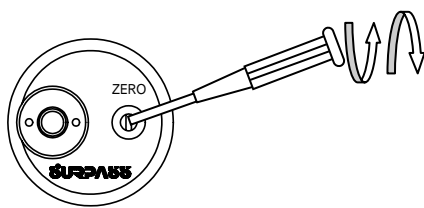

Externally displayed pressure: 0 kPa
Output values

Current : 4 mA
Voltage : 1 V (1 to 5 V)
0 V (0 to 10 V)

* When adjusting the ZERO point, use a slotted screwdriver of correct size not to apply any unnecessary load.

- (4) Check the zero tracking is complete, attach the cap and start using the pressure sensor.

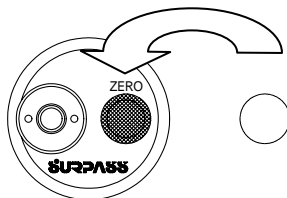

* Periodically provide the zero tracking.

⚠ CAUTION

Before doing the zero tracking procedure, be sure the pressure sensor is in a non-pressurized state.

【Compound Pressure TYPE】

- (1) Make sure that your Pressure Sensor is not in a pressurized condition.
- (2) Remove the cap (black) from the cable side of the pressure sensor.

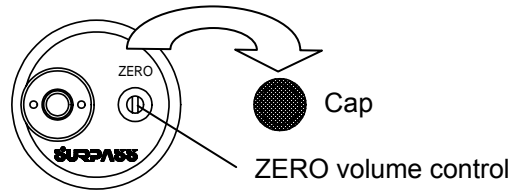

- (3) Adjust the externally displayed pressure or output values are as shown below by tuning the ZERO volume control using a slotted screwdriver.

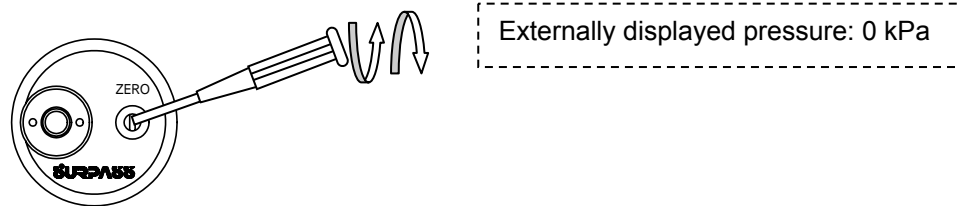

【Compound Pressure TYPE】

Pressure Range	Output set up values	Output Current values (4 to 20 mA)	Output Voltage values (1 to 5 V)	Output Voltage values (0 to 10 V)
-100 ~ 300 kPa		8 mA	2 V	2.5 V
-100 ~ 500 kPa		6.67 mA	1.67 V	1.67 V

* When adjusting the ZERO point, use a slotted screwdriver of correct size not to apply any unnecessary load.

- (4) Check the zero tracking is complete, attach the cap and start using the pressure sensor.

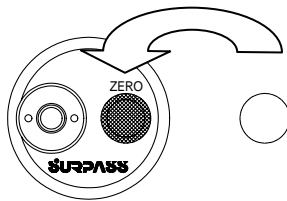

* Periodically provide the zero tracking.

⚠ CAUTION
Before doing the zero tracking procedure, be sure the pressure sensor is in a non-pressurized state.

Maintenance and Inspection

The Pressure Sensor should be inspected regularly, about twice a year depending on the usage.

During the regular inspection, check the

- appearance
- corrosion, clogging, leakage, etc., from the connector parts.

The Pressure Sensor should be flushed periodically if using liquids that crystallize easily.

<Safety Notes on Maintenance and Inspection>

 DANGER unless these precautions are not obeyed!	
<ul style="list-style-type: none"> ● If using dangerous chemicals, solvents, gases, etc., make sure to wear protective, chemical resistant gear (protective gloves, mask, and clothing) to protect your entire body. Ejected liquids may result in physical impairment. ● Before disconnecting this product from the piping system, make sure the line is depressurized. Otherwise, the fluid inside will eject and may result in physical impairment. ● When replacing parts, or when performing maintenance or inspection, turn off the switch, and release the fluid inside the piping to depressurize the line. Otherwise, the fluid inside will eject and may result in physical impairment. 	

In Case of Breakdown

Symptom	Cause	Countermeasure
No output.	Incorrect wiring.	Check the wiring diagram and correct the wiring.
	Incompatible power, voltage.	Check the power supply and voltage.
Output is not changed.	Your piping system is not in a pressurized condition.	Check your piping system.
Zero point is shifted.	The equipment has not been warmed up	After warm up the equipment for least 20 minutes, you need to do zero tracking.
	Your piping system is in a pressurized state.	Depressurize your piping system.
	Fails to zero tracking.	Adjust predetermined current and voltage by turning the zero volume. Please make the situation that the pressure sensor is not in a pressurized condition. (Please refer to P7 ~ P8 for predetermined current and voltage.)
The analog output value is unstable.	The equipment has not been warmed up.	Warm up the equipment for at least 20 minutes.
	There is noise-generating equipment nearby.	Move the noise-generating equipment from the vicinity.
	The shield wire is not grounded.	Ground the shield wire.
	The pressure inside your piping system is fluctuating.	Stop the pressure inside your piping system from fluctuating.

Notify your nearest sales office for problems not listed above.

Notes on Warranty

The warranty runs for one year after the day when Surpass Industry products are delivered from Surpass factory in Japan. In case Surpass Industry should agree in writing that the defects in performance or material were caused by faulty design or workmanship of Surpass Industry, replacement products will be supplied free of charge. This warranty shall not be applied to any defects caused by misuse, alteration, neglectful treatment, and neglect of our recommendations or instructions.

In addition, we are not be liable to any direct or consequential loss, damage, and personal injury due to an unauthorized usage in combination with other products and an improper usage outside of the specifications. Our product warranty shall be limited to replacement of product.

Replacement with expense to the purchaser shall be applied to the followings:

- Any defective products caused by usage that is not described in the Instruction Manual.
- Any defective products caused by neglectful treatment.
- Any defective products caused by decomposition, alteration, and improper adjustment or repair.
- Any defects of products caused by acts of God including natural disaster or fires.
- Consumables and accessories.

The logo for Surpass Industry Co., Ltd. features the word "SURPASS" in a bold, blue, sans-serif font. A small red circle is positioned above the letter "S".

Surpass Industry Co., Ltd.

2203 Shimooshi, Gyoda-shi, Saitama 361-0037 Japan

TEL: +81 48 554 9760 FAX: +81 48 554 9906

URL: <http://www.surpassindustry.co.jp>

© 2004-2011 Surpass Industry Co.,Ltd. All rights reserved.